



This manual covers the following models:

- **T725**

## Thermostat Applications Guide

Description	
Gas or Oil Heat	No
Electric Furnace	No
Heat Pump (No Aux. or Emergency Heat)	Yes
Heat Pump (with Aux. or Emergency Heat)	Yes
Multi-stage Systems	No
Heat Only Systems	No
Heat Only Systems - Floor or Wall Furnaces	No
Cool Only Systems	No
Millivolt	No

## Power Type

- Battery Power
- Hardwire (Common Wire)
- Hardwire (Common Wire) with Battery Backup

## Table of Contents

### Page

Installation Tips	2
Thermostat Quick Reference	3
Subbase Installation	4
Wiring	5-6
Technician Setup	7
Technician Setup Menu	8-9
Mounting and Battery Installation	10
Programming The Thermostat	11-12
Specifications	13

Una versión española de este manual puede ser descargada en [www.pro1iaq.com](http://www.pro1iaq.com)

### A trained, experienced technician must install this product.

Carefully read these instructions. You could damage this product or cause a hazardous condition if you fail to follow these instructions.

### Need Help?

For assistance with this product please visit <http://www.pro1iaq.com> or call Pro1 Customer Care toll-free at 888-Pro1iaq (776-1427) during normal business hours (Mon-Fri 9 AM - 6 PM Eastern)

## Wall locations

---

The thermostat should be installed approximately 4 to 5 feet above the floor. Select an area with average temperature and good air circulation.

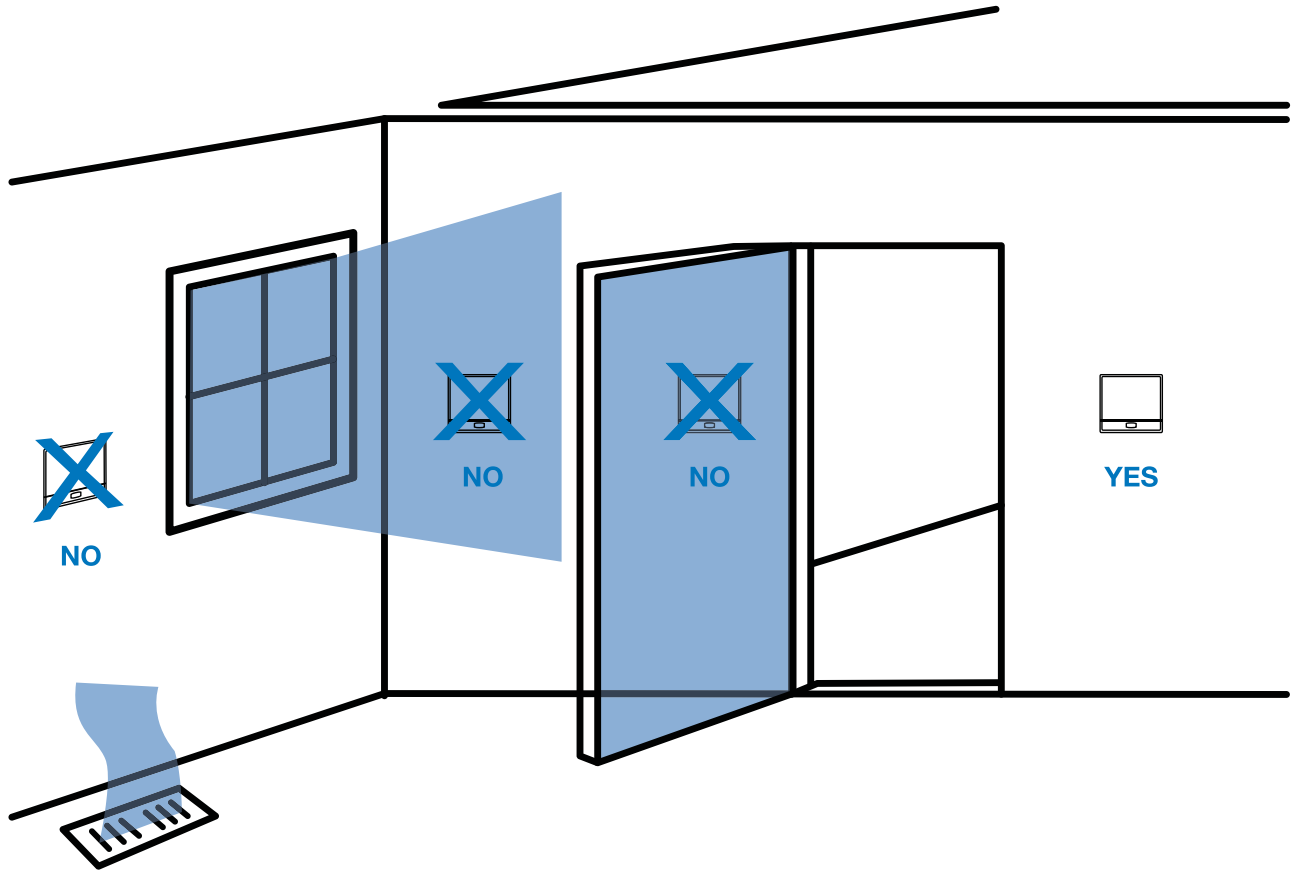

**Do not install** thermostat in locations:

- Close to hot or cold air ducts
- That are in direct sunlight
- With an outside wall behind the thermostat
- In areas that do not require conditioning
- Where there are dead spots or drafts (in corners or behind doors)
- Where there might be concealed chimneys or pipes
- Where appliances could radiate heat

## PRO1 Tip

---

Pick an installation location that is easy for the user to access. The temperature of the location should be representative of the building.

## Getting to know your thermostat

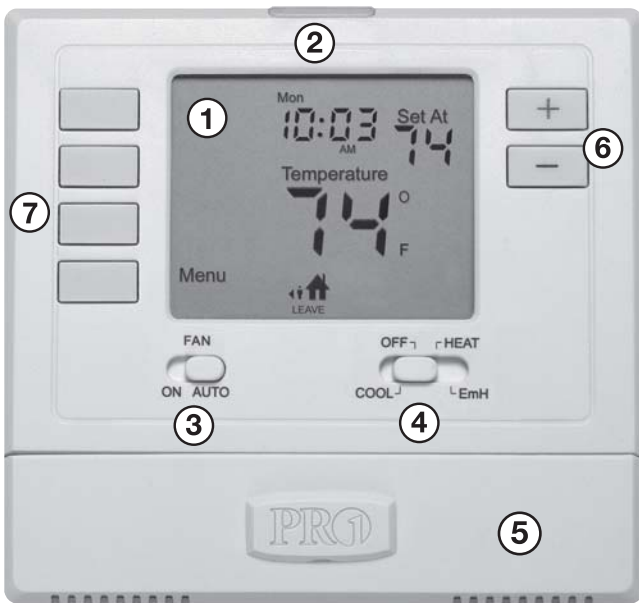

- ② Glow in the Dark Light Button
- ③ Fan Switch
- ④ System Switch
- ⑤ Easy Change Battery Door
- ⑥ Setpoint Buttons
- ⑦ User Buttons

① LCD

Displays the user selectable setpoint temperature.

Days of the week and time

Button options

Indicates the current room temperature.

**Programmable Time Period Icons:** This thermostat has 4 programmable time periods per day.

WAKE LEAVE RETURN SLEEP

Hold is displayed when thermostat program is permanently overridden.

\*\* COOL HEAT FAN

**System operation indicators:** The COOL, HEAT or FAN icon will display when the COOL, HEAT or FAN is on. NOTE: The compressor delay feature is active if these icons are flashing. The compressor will not turn on until the 5 minute delay has elapsed.

**Low Battery Indicator:** Replace batteries when indicator is shown.

+1 will appear in the display when the auxiliary heat is active.



### Important:

The low battery indicator is displayed when the AA battery power is low. If the user fails to replace the battery within 21 days, the thermostat display will only show the low battery indicator as a final warning before the thermostat becomes inoperable.

## Removing the private label badge

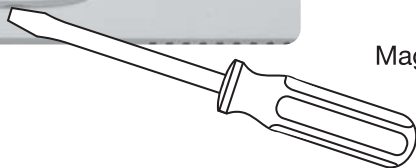

Use the bevel on lower ridge

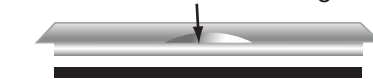

Magnet in door

Gently slide a screwdriver into the bottom edge of the badge. Gently turn the screwdriver counter clockwise. The badge is held on by a magnet in the well of the battery door. The badge should pry off easily. **Do not use force.**

### PRO1 Tip

All Pro1 thermostats use the same universal magnetic badge. Visit our website at [www.pro1iaq.com](http://www.pro1iaq.com) to learn more about our free private label program.



### Caution: Electrical Hazard

Failure to disconnect the power before beginning to install this product can cause electrical shock or equipment damage.



### Mercury Notice:

All of Pro1's products are mercury free. However, if the product you are replacing contains mercury, dispose of it properly. Your local waste management authority can give you instructions on recycling and proper disposal.

For vertical mount put one screw top and one screw bottom.

For horizontal mount put one screw left and one screw right.

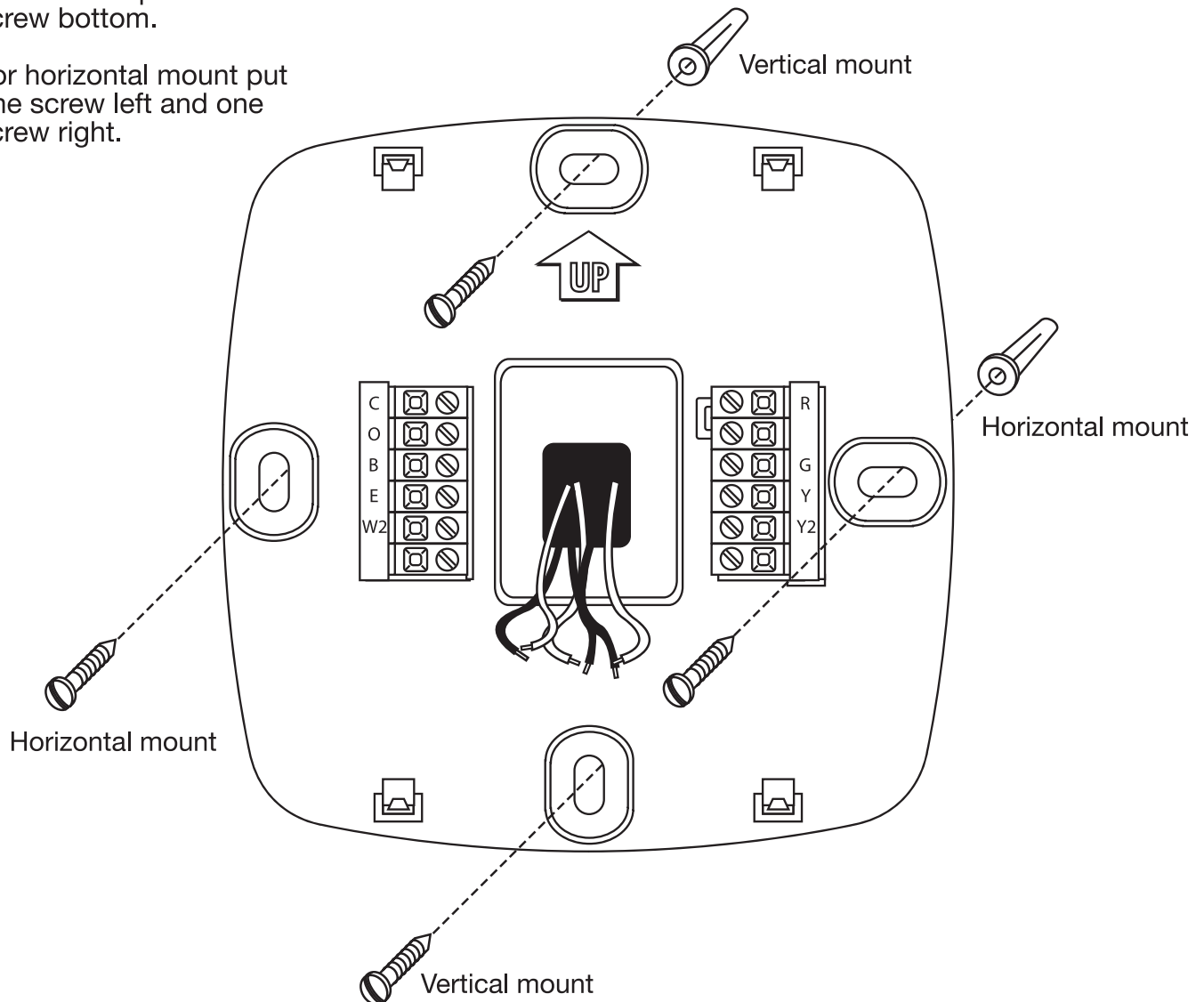

## New Thermostat Installation Wiring

- 1 Power supply.
- 2 Use either O or B terminals for changeover valve.
- 3 Optional 24 VAC common connection when thermostat is used in battery power mode.

### Typical 2H/1C heat pump system

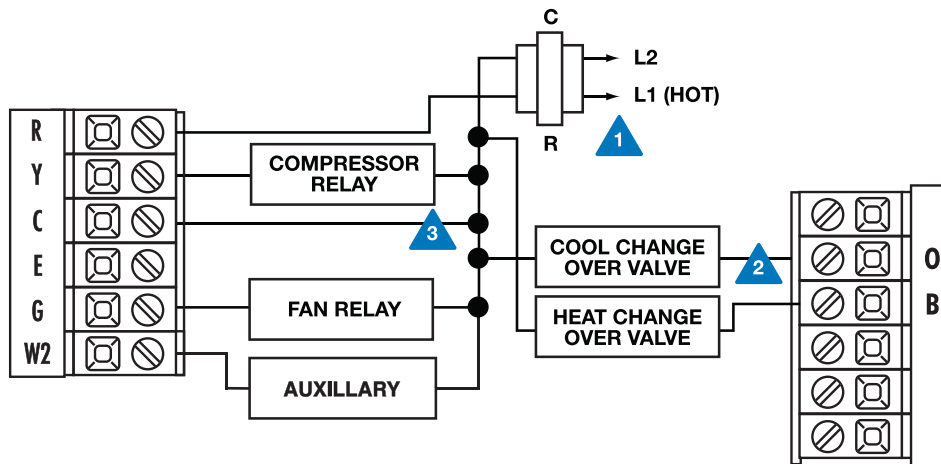

**NOTE:** In many systems with no emergency heat relay a jumper can be installed between E and W2.



### Caution: Electrical Hazard

Failure to disconnect the power before beginning to install this product can cause electrical shock or equipment damage.



### Warning:

All components of the control system and the thermostat installation must conform to Class II circuits per the NEC Code.

## Wiring

1. If you are replacing a thermostat, make note of the terminal connections on the thermostat that is being replaced. In some cases the wiring connections will not be color coded. For example, the green wire may not be connected to the **G** terminal.
2. Loosen the terminal block screws. Insert wires then retighten terminal block screws.
3. Place nonflammable insulation into wall opening to prevent drafts.

Brand	24V Common	24V Hot	Changeover in Cooling	Changeover in Heating	Fan	Emergency Heat	Compressor	Auxiliary Heat	Malfunction Light
<b>Pro1</b>	<b>C (optional)</b>	<b>R</b>	<b>O</b>	<b>B</b>	<b>G</b>	<b>E</b>	<b>Y</b>	<b>W2</b>	<b>None, Tape Off</b>
Arco/Snyder	C	R	O		G	E	Y	W1	X
B.D.P.	C	R	O		G	E	Y	W1	F
Carrier	C	R	O		G	E	Y	W2	L
Coleman	BLCK	RED	V		G		Y	W2	
G.E.	B	R	O		G	X2	Y	W	
Heil-Quaker	B	R	O		G		Y	W2	
Honeywell	C	R	O	B	G	E	Y	Aux	L
Janitrol	C	R	O		G	E	Y	W2	
Lennox	X	V/VR	R		F	E	M	Y	L
Magic Chef	C	R	O		G	E	Y	W	
Rheem	X	R		B	G	E	Y	W2	L
Ruud	X	R		B	G	E	Y	W2	L
Trane	B	R	O		G	X2	Y	W	F
Weatherking	C	R	Y1		G		W1	E	
Wesco	C	R	Y1		G	E	W1	W2	
Westinghouse	X	R/V	O	Z	G/F	E	Y/C	W/H2	
White-Rodgers	C	R	O	B	G	E	Y	W2	L
York	B	R	O		G		Y	W	

**Note:** This cross reference represents typical systems and is not necessarily representative of your particular application. Always consult the original equipment manufacturer for proper installation instructions.

### Terminal Designations

- W2** Auxiliary heat relay - Stage 2
- Y** Compressor relay - Stage 1
- G** Fan relay
- O** Heat pump changeover valve energized in cooling
- R** Transformer power

- C** Common wire from system transformer
- B** Heat pump changeover valve energized in heating
- E** Emergency heat relay

**Note:**

In many systems with no emergency heat relay a jumper can be installed between E and W2.

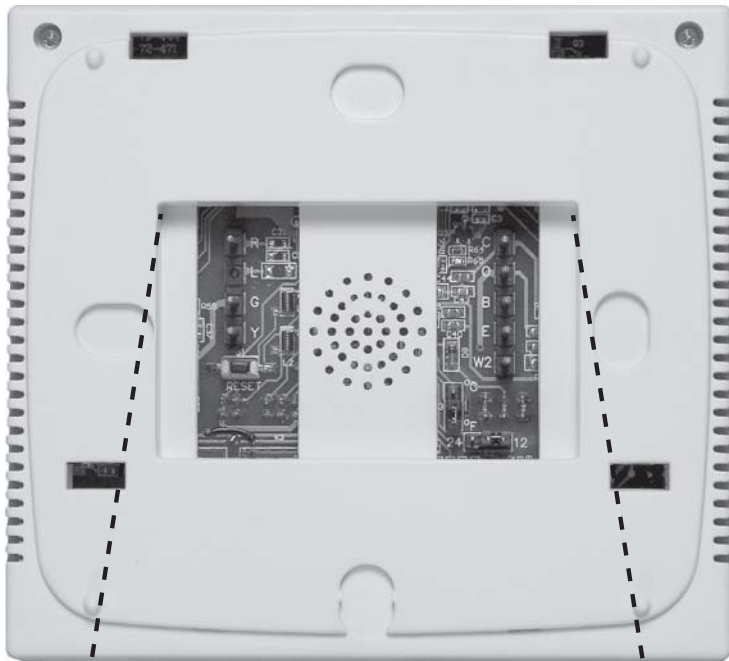

### Fahrenheit/Celsius Display

Select **F** or **C** with the jumper pin on the back of the thermostat. **F** is for Fahrenheit and **C** is for Celsius.

### 12 or 24 Hour Time

12 or 24 hour (military time) can be selected with the jumper pin.

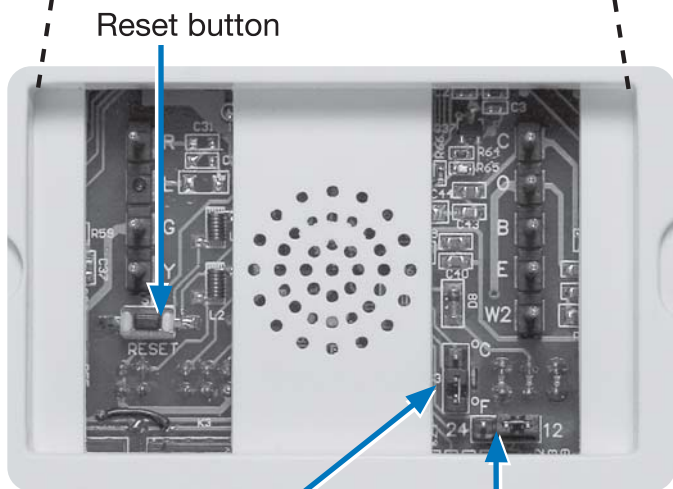

Reset button

Select **F** or **C** with the jumper pin

12 or 24 hour jumper pin

**Important:**



The **RESET** button must be pressed after changing any switch or jumper pin setting. Batteries must be installed for this operation.



## Technician Setup Menu

This thermostat has a technician setup menu for easy installer configuration. To set up the thermostat for your particular application:

1. Press **MENU** button
2. Press and hold **TECH SET** button for 3 seconds. This 3 second delay is designed so that homeowners do not accidentally access the installer settings.

3. Configure the installer options as desired using the table below.



Use the **+** or **-** keys to change settings and the **NEXT STEP** or **PREV STEP** key to move from one option to another. **Note:** Only press **DONE** key when you want to exit the Technician Setup options.

Tech Setup Steps						
Filter Change Reminder	Room Temperature Calibration	Minimum Compressor On Time	Compressor Short Cycle Delay	Cooling Swing	Heating Swing	Gas Auxiliary for Heat Pump
This feature will flash "FLT" in the display after the elapsed run time to remind the user to change the filter. A setting of "off" will disable this feature.	This feature allows the installer to change the calibration of the room temperature display. For example, if the thermostat reads 70° and you would like it to read 72° then select +2.	This feature allows the installer to select the minimum run time for the compressor. For example, a setting of 4 will force the compressor to run for at least 4 minutes every time the compressor turns on, regardless of the room temperature.	The compressor short cycle delay protects the compressor from "short cycling". This feature will not allow the compressor to be turned on for 5 minutes after it was last turned off.	The swing setting, often called "cycle rate", "differential" or "anticipation" is adjustable. A smaller swing setting will cause more frequent cycles and a larger swing setting will cause fewer cycles.	The swing setting, often called "cycle rate", "differential" or "anticipation" is adjustable. A smaller swing setting will cause more frequent cycles and a larger swing setting will cause fewer cycles.	When on, this feature turns off the Y terminal 45 seconds after the second stage of heat turns on.
LCD Will Show						
Adjustment Options						
You can adjust the filter change reminder from "off" to 2000 hours of runtime in 50 hour increments.	You can adjust the room temperature display to ready -4°F to +4°F above or below the factory calibrated reading.	You can select the minimum compressor run time from "off", "3", "4", or "5" minutes. If 3, 4, or 5 is selected, the compressor will run for at least the selected time before turning off.	Selecting "ON" will not allow the compressor to be turned on for 5 minutes after the last time the compressor was on. Select "off" to remove this delay.	The cooling swing setting is adjustable from ±0.4°F to ±2°F. For example: A swing setting of 0.5°F will turn the cooling on at approximately 0.5°F above the setpoint and turn the cooling off at approximately 0.5°F below the setpoint.	The heating swing setting is adjustable from ±0.4°F to ±2°F. For example: A swing setting of 0.5°F will turn the heating on at approximately 0.5°F below the setpoint and turn the heating off at approximately 0.5°F above the setpoint.	Selectable on or off. This option should be "ON" for "DUAL FUEL" applications that use a gas furnace for auxiliary heat.
Factory Default Settings						
Off	0 °F	Off	On	0.8 °F	0.8 °F	Off

## PRO1 Tip

The second stage will turn on at 2x the swing setting. The second stage will turn off when 1x the swing is reached. For example, if the swing setting is .8 degrees for heating and the thermostat is set at 70°F, the first stage will turn on at approximately 69.2°F. The second stage will turn on at 68.4°F. The second stage will turn off at 69.2°F and the first will turn off at 70.8°F.



Tech Setup Steps (Continued...)	
Satisfy Setpoint	Staging Delay
<p>This feature allows the thermostat to keep multiple stages of heat or cool energized until setpoint is satisfied.</p>	<p>This feature allows a delay to occur when a second and third stage is needed. This allows the previous stage extra time to satisfy setpoint.</p>
LCD Will Show	
	
Adjustment Options	
<p>Use the <b>+</b> or <b>-</b> key to turn on or off.</p>	<p>Use the <b>+</b> or <b>-</b> key to select OFF, 5, 10, 15, 30, 45, 60, 90.</p>
Factory Default Settings	
OFF	OFF

**Note:**

Pro1 Standard staging logic, optional satisfy setpoint and optional staging delay allows for job by job customization that balances comfort, energy efficiency and equipment longevity.

# INSTALLATION MANUAL

## MOUNT THERMOSTAT & BATTERY INSTALLATION

### Mount Thermostat

Align the 4 tabs on the subbase with corresponding slots on the back of the thermostat, then push gently until the thermostat snaps in place.



### Battery Installation

Battery installation is optional if thermostat is hardwired (C terminal connected).

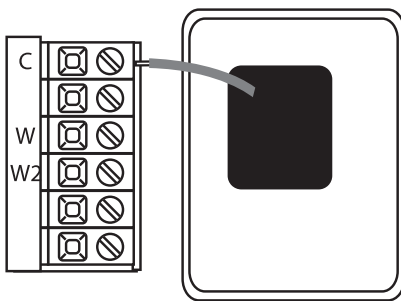

Insert 2 AA Alkaline batteries (included).

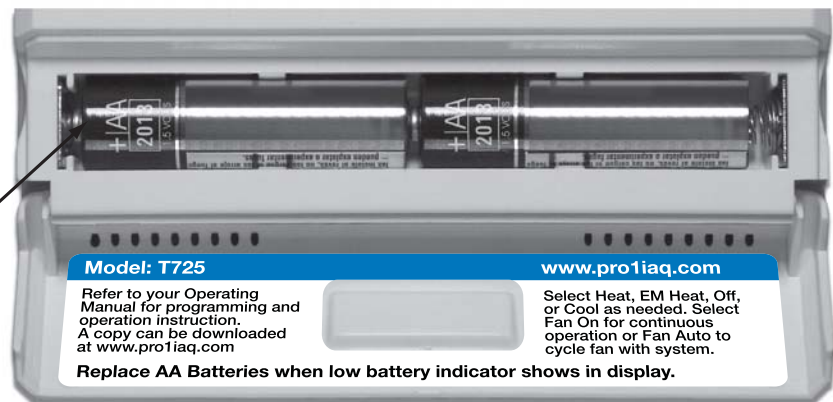

Simple operating instructions are found on the back of the battery door.

### Set Time













Follow the steps below to set the day of the week and current time:

1. Press **MENU**
2. Press **SET TIME**
3. Day of the week will be flashing. Use the  or  key to select the current day of the week.
4. Press **NEXT STEP**
5. The current hour is flashing. Use the  or  key to select the current hour. When using 12-hour time, make sure the correct a.m. or p.m. choice is selected.
6. Press **NEXT STEP**
7. Minutes are now flashing. Use the  or  key to select current minutes.
8. Press **DONE** when completed

### Programming













All programmable Pro1 thermostats are shipped with an energy saving pre-program. You can customize this default program by following the Set Program Schedule.

Your thermostat can be programmed to have all the weekdays the same, a separate program for Saturday, and a separate program for Sunday. There are four time periods for each program (**WAKE, LEAVE, RETURN, SLEEP**).

Factory Default Program				
Day of the Week	Events	Time	Setpoint Temperature (Heat)	Setpoint Temperature (Cool)
Weekday	Wake 	6 a.m.	70° F (21° C)	75° F (24° C)
	Leave 	8 a.m.	62° F (17° C)	83° F (28° C)
	Return 	6 p.m.	70° F (21° C)	75° F (24° C)
	Sleep 	10 p.m.	62° F (17° C)	78° F (26° C)
Saturday	Wake 	8 a.m.	70° F (21° C)	75° F (24° C)
	Leave 	10 a.m.	62° F (17° C)	83° F (28° C)
	Return 	6 p.m.	70° F (21° C)	75° F (24° C)
	Sleep 	11 p.m.	62° F (17° C)	78° F (26° C)
Sunday	Wake 	8 a.m.	70° F (21° C)	75° F (24° C)
	Leave 	10 a.m.	62° F (17° C)	83° F (28° C)
	Return 	6 p.m.	70° F (21° C)	75° F (24° C)
	Sleep 	11 p.m.	62° F (17° C)	78° F (26° C)

# INSTALLATION MANUAL PROGRAMMING THE THERMOSTAT

You can use the table below to plan your customized program schedule.

Programming Table				
Day of the Week	Events	Time	Setpoint Temperature (Heat)	Setpoint Temperature (Cool)
Weekday	Wake 			
	Leave 			
	Return 			
	Sleep 			
Saturday	Wake 			
	Leave 			
	Return 			
	Sleep 			
Sunday	Wake 			
	Leave 			
	Return 			
	Sleep 			

## Set Program Schedule

To customize your program schedule, follow these steps

### Weekday:

1. Select **HEAT** or **COOL** from the system switch.  
**Note:** You have to program heat and cool each separately.
2. Press **MENU**
3. Press **SET SCHED**. Note: Monday-Friday is displayed and the **WAKE** icon is shown. You are now programming the wake time period for the weekday setting.
4. Time is flashing. Use the  or  key to make your time selection for the weekday **WAKE** time period.
5. Press **NEXT STEP**
6. The setpoint temperature is flashing. Use the  or  key to make your setpoint selection for the weekday wake period.
7. Press **NEXT STEP**
8. Repeat steps 4 through 7 for weekday **LEAVE** time period, for weekday **RETURN** time period, and for weekday **SLEEP** time period.

### Saturday:

9. Repeat steps 4 through 7 for Saturday **WAKE** time period, for Saturday **LEAVE** time period, for Saturday **RETURN** time period, and for Saturday **SLEEP** time period.

### Sunday:

10. Repeat steps 4 through 7 for Sunday **WAKE** time period, for Sunday **LEAVE** time period, for Sunday **RETURN** time period, and for Sunday **SLEEP** time period.

### Specifications

---

The display range of temperature .....	41°F to 95°F (5°C to 35°C)
The control range of temperature .....	44°F to 90°F (7°C to 32°C)
Load rating .....	1 amp per terminal, 1.5 amp maximum all terminals combined
Display accuracy .....	± 1°F
Swing (cycle rate or differential) .....	Heating is adjustable from 0.2°F to 2.0°F Cooling is adjustable from 0.2°F to 2.0°F
Power source .....	18 to 30 VAC, NEC Class II, 50/60 Hz for hardwire (common wire) Battery power from 2 AA Alkaline Energizer batteries
Operating ambient .....	32° to +105° (0° to +41°C)
Operating humidity .....	90% non-condensing maximum
Dimensions of thermostat .....	4.7"W x 4.4"H x 1.1"D

### Contact Us

---

#### **Pro1 IAQ Inc.**

1111 S. Glenstone  
Suite 2-100  
Springfield, MO 65804

**Toll-free:** 1-888-Pro1iaq (776-1427)

**Toll Number (Outside the USA):** 330-821-3600

**Web:** <http://www.pro1iaq.com>

**Hours of Operation:** Monday - Friday 9 AM - 6 PM Eastern